

March 21, 1939.

H. SELMER

2,151,337

MUSICAL INSTRUMENT

Original Filed March 27, 1935

4 Sheets-Sheet 2

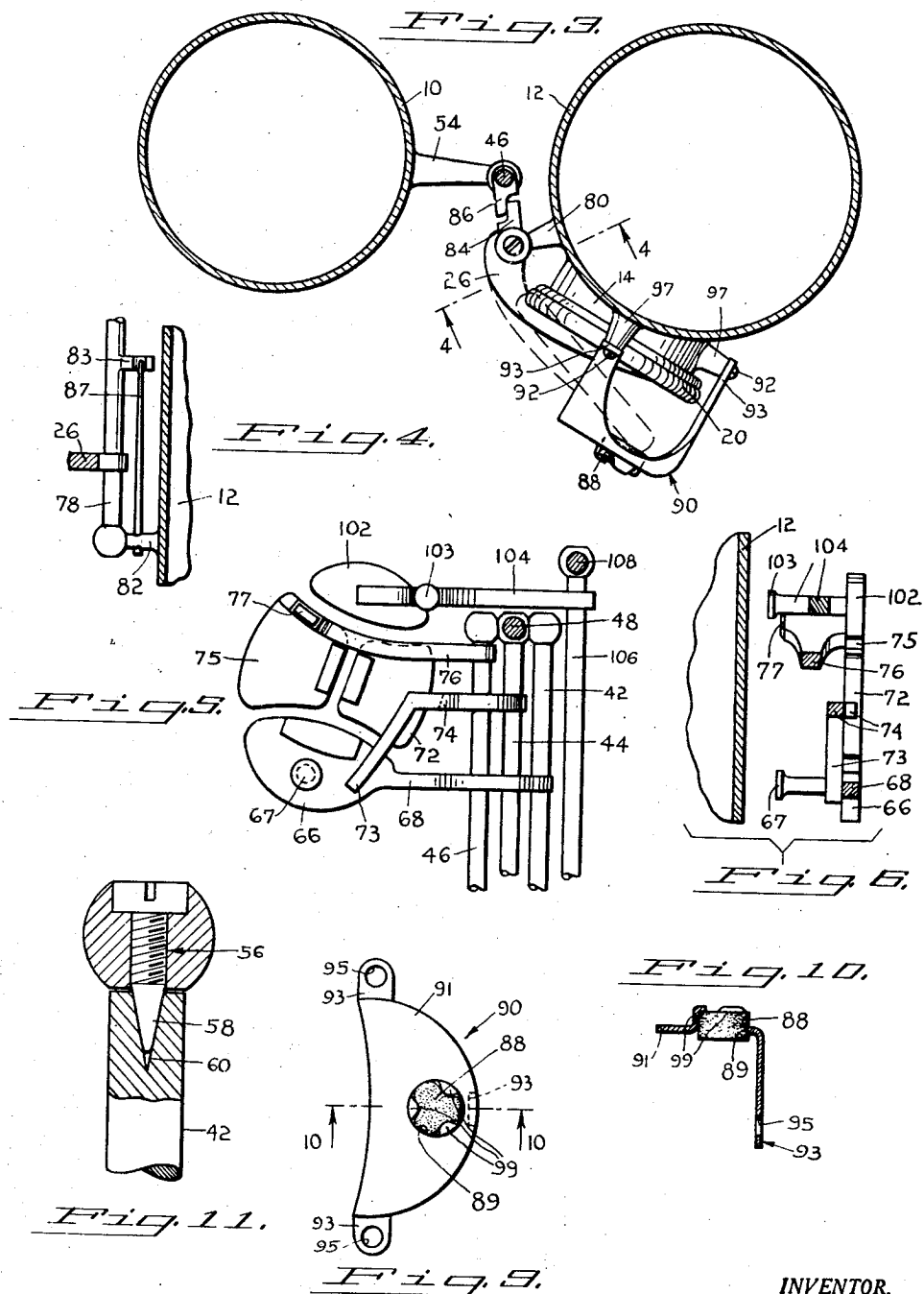

INVENTOR.
HENRI SELMER.
BY *Edwin Leisoku*
ATTORNEYS.