

4/4

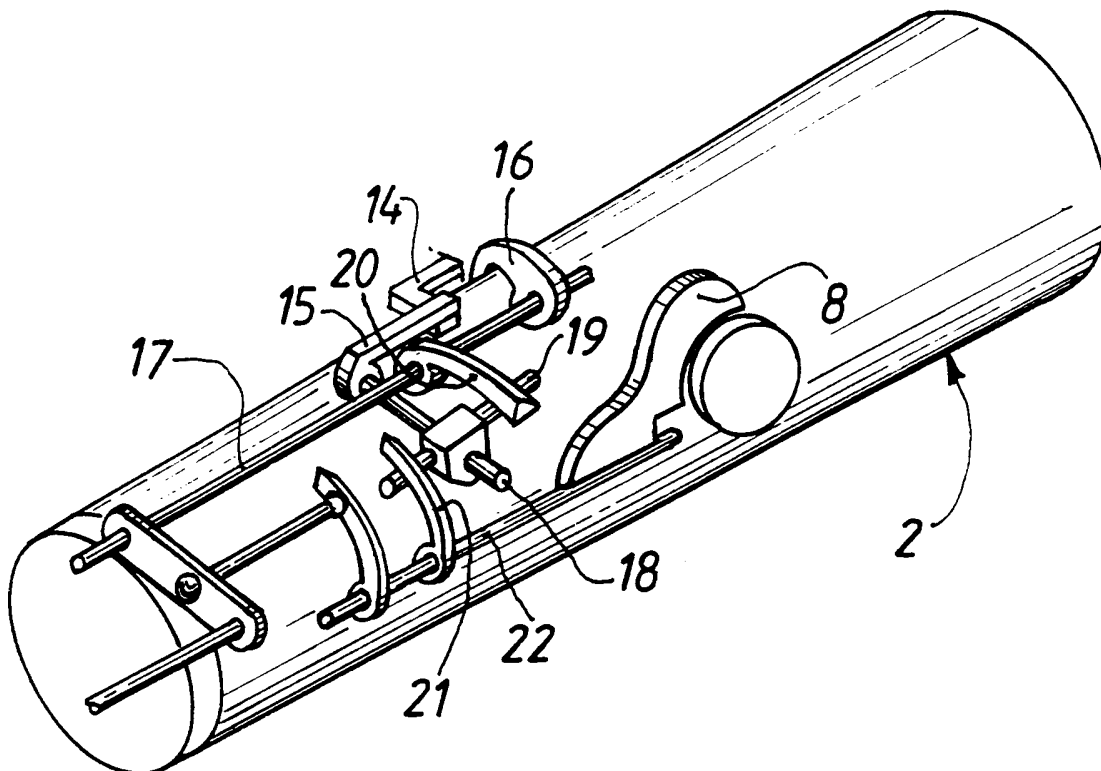

FIG.6